

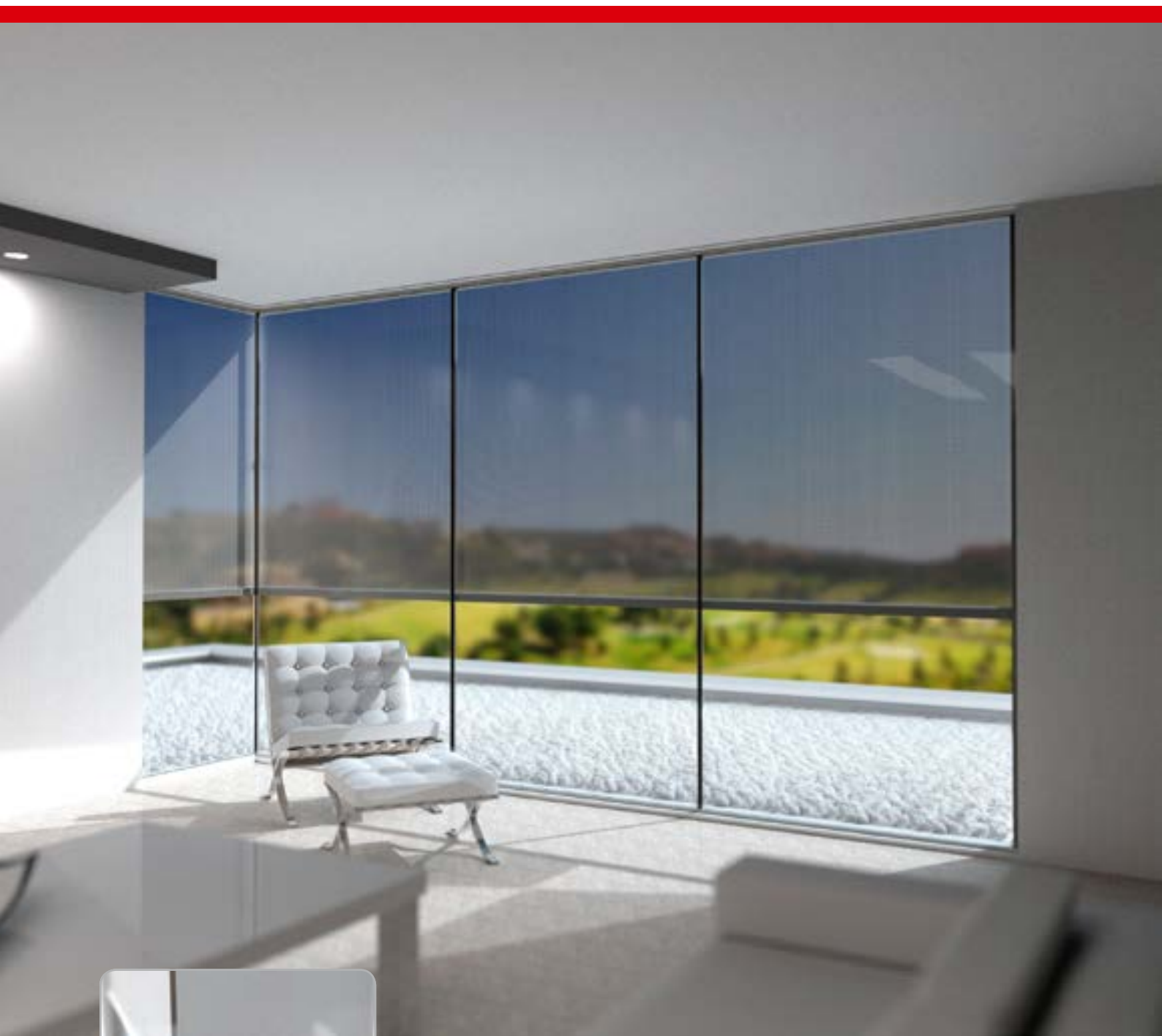

Creating healthy spaces



PATENTED TECHNOLOGY & PATENT PENDING

Panovista®

The first sun protection for glass-on-glass corner windows

Panovista®

RENSON®. a trendsetter in sunprotection, follows architectural trends closely. "Invisible architecture" is a new trend that goes well with the desire for minimalism. RENSON® is taking perfect advantage of this development with the Panovista®. This new development is ideal for applications with glass-on-glass corner windows, for which conventional screens fail to provide a solution. The Panovista® is a sunscreen for corner windows, keeping the unpleasant aluminium profiles or cables from being permanently visible in the corner. Both sides of the system are simultaneously rolled up or out, and in this way provide the desired shade for a living or work space, without losing the view of the panorama around the building. This solution is almost invisibly integrated into the building's architecture. The box and side channels can be aesthetically hidden away and even the bottom bar disappears into the box once the screen is fully rolled up.

Product

- Both sides of this corner screen move simultaneously.
- The box and side channels can be hidden away:
 - The box (H 150 x D 110 mm) can be integrated into the cavity, in which the fabric roller & motor can be easily assembled/disassembled from beneath.
 - The side channels can be hidden.
 - The bottom bar disappears into the box.
 - There are no vertical side channels in the corner, thus maintaining the panoramic view.
- It is also perfectly applicable during a renovation; the box can be surface-mounted in this case.
- Electric control: the two screens are controlled by a single motor. Wind sensor is necessary.
- Profiles can have an anodised finish or are available in any RAL colour.
- Fabric choice: glass fibre fabric. Available in various colours.

Applications

- Fixed glass-on-glass corner, e.g. glued corner joint
- Open glass-on-glass corner, e.g. sliding windows
- Surface-mounted/built-in
- New-build/renovation

Technical properties

- Width: Section 1: max. 4,000 mm + Section 2: max. 4,000 mm
- Height: Section 1/Section 2: max. 2,700 mm (including the box)
- Box dimensions: H 150 mm x D 110 mm
- Angle: 90°

Guarantee

- 5-year product guarantee
- 10-year guarantee for powdercoating
- Compliant with European norm EN 13561, wind class WC2

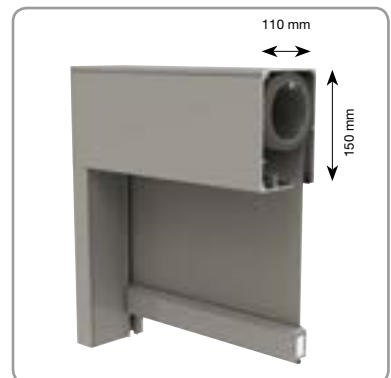

Dealer



RENSON® reserves the right to make technical changes to the products shown. The latest brochures may be downloaded from www.renson.eu

RENSON® Export Department • Tel. +32 (0)56 62 71 11 • export@renson.net

RENSON® Sunprotection-Screens NV
IZ 1 Flanders Field • Kalkhoevestraat 45 • B-8790 Waregem
Tel. +32 (0)56 62 65 00 • Fax +32 (0)56 62 65 09
export@renson.be • www.renson.eu

RENSON® Fabrications LTD
Fairfax Units 1-5 • Bircholt Road • Parkwood Industrial Estate • Maidstone • Kent ME15 9SF
Tel. 01622/754123 • Fax 01622/689478
info@rensonuk.net • www.renson.eu



Creating healthy spaces